

**Caratteristiche tecniche** - Credenza con 4 ante realizzata in massello di noce americano e multistrato di pioppo impiallacciato. Mensola a giorno con piani in vetro trasparente, bronzato o fumé. N°3 scomparti interni in acero con n°1 mensola in vetro trasparente in ogni scomparto. Piano e schienale a giorno in legno, laccato lucido, laccato opaco o marmo. Su richiesta accessori interni.

**Technical features** - Sideboard with 4 doors, made in solid American walnut and veneered poplar plywood. Open shelf with tops in transparent, bronzed, or smoked glass. N°3 internal compartments in maple with n°1 transparent glass shelf in each compartments. Top and open back panel in wood, matt lacquered, gloss lacquered or marble. On request internal accessories.

**Nota** - Specificare la finitura del legno, tra quelle presenti a campionario. Specificare la finitura del vetro per i piani della mensola a giorno: trasparente, bronzato o fumé. Se non specificato, il top e l'alzata vengono considerati in legno di noce americano, nella finitura scelta per la struttura del mobile. Per la finitura laccato specificare il colore NCS o RAL.

**Note** - Specify the wood finish from the available samples. Specify glass finish for the open shelf tops: transparent, bronzed, or smoked. If not specified consider the finish of the top and open back panel in American walnut, in the same color chosen for the structure. To specify the NCS or RAL color for lacquered version.

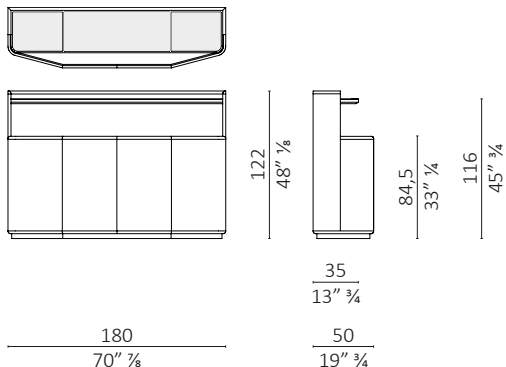

## Accessori / Accessories

### Top

**Caratteristiche tecniche** - Piano laccato lucido, laccato opaco o marmo in alternativa al piano in legno.

**Technical features** - Top in marble, matt lacquered or gloss lacquered finish in alternative to the wooden top.

### Cassetto interno in acero / Internal maple drawer

**Caratteristiche tecniche** - Cassetto interno per il vano centrale della credenza.

**Technical features** - Internal drawer for central compartment of the sideboard.

### Fondo cassetto / Drawer bottom

**Caratteristiche tecniche** - Fondo cassetto in pelle.

**Technical features** - Bottom of drawer in leather.

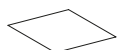

### Schienale a giorno / Open back panel

**Caratteristiche tecniche** - Schienale a giorno laccato lucido, laccato opaco o marmo in alternativa al legno.

**Technical features** - Open back panel in marble, gloss lacquered or matt lacquered finish in alternative to the wooden one.

### Divisorio / Partition 8

**Caratteristiche tecniche** - Divisorio cassetto in noce nella stessa finitura scelta per la struttura.

**Technical features** - Internal drawer partition in walnut with the same finish as that chosen for the structure.

### LED interno / internal

**Caratteristiche tecniche** - Luce LED interna con accensione all'apertura dell'anta.

**Technical features** - Internal LED lights with door opening control.

## LED esterno / external

**Caratteristiche tecniche** - Luce LED esterna integrata nella mensola a giorno, con accensione touch control.

**Technical features** - Built-in external LED light with touch control positioned in the open shelf.

## Finiture / Finishes

### Legno Noce / Wood Walnut

---

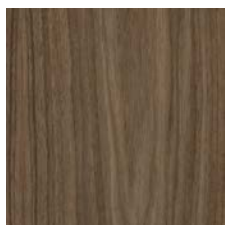

Noce  
*Walnut*

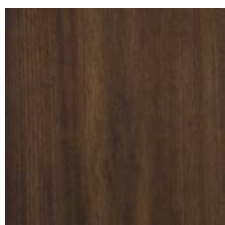

Noce dark  
*Walnut dark*

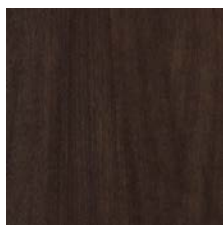

Noce moka  
*Walnut moka*

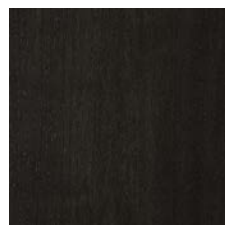

Noce brown  
*Walnut brown*

### Laccato / Lacquered

---



NCS S7010G10Y

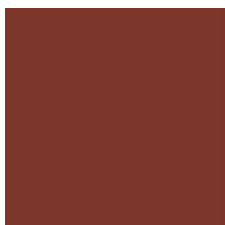

NCS S5040Y80R



NCS S3502Y

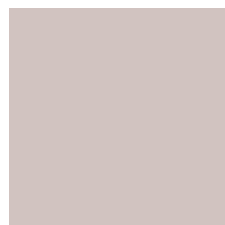

NCS S2010R



NCS S3030Y10R



NCS S6010R90B



NCS S8010R90B

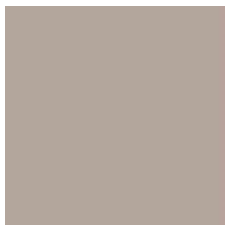

NCS S3005Y50R

### Marmo / Marble

---

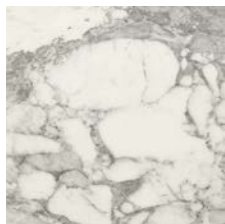

Cervaiolo



Calacatta  
*Calacatta Oro*

## Finiture / Finishes

### Metallo Ottone / Metal Brass

---

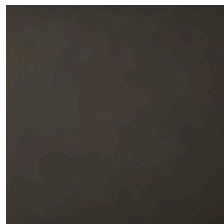

Ottone brunito  
*Burnished brass*

### Pelle / Leather Color Sphere PF

---

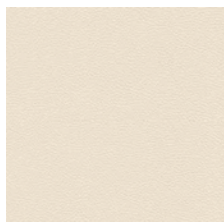

SC 06 Calicot



SC 23 Tortora



SC 32 Caolino

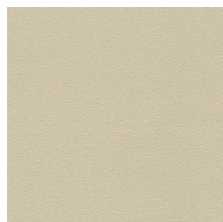

SC 51 Panna



SC 31 Quarzo Fumè



SC 34 Maggese



SC 26 Topo

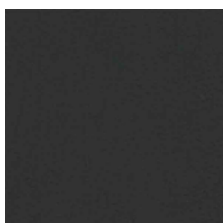

SC 20 Inchiostro



SC 21 Amianto



SC 53 Creta



SC 55 Camel Hair



SC 52 Daino



SC 66 India



SC 59 Noce di Pecan



SC 80 Bruno Havana



SC 29 Ardesia



SC 148 Lacca



SC 146 Coccio Pesto



SC 173 Glauco



SC 177 Limo

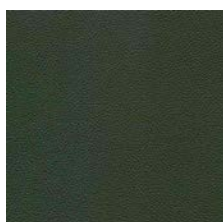

SC 178 Alpi

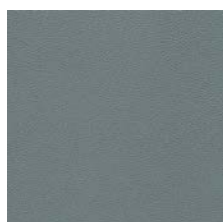

SC 254 Steel Blue



SC 278 Atlantic Blue

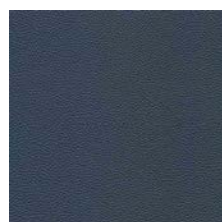

SC 279 Alchemy

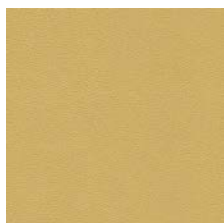

SC 133 Paglierino