

## Rive Droite scrivania / desk

design Christophe Pillet

**Caratteristiche tecniche** - Scrivania realizzata in massello di noce americano e multistrato impiallacciato noce americano con 6 cassetti. Piano con sottomano in pelle, passaggio cavi con ribaltina in legno.

**Technical features** - Writing desk made in solid American walnut and plywood veneered American walnut with 6 drawers. Top with leather pad, electrical cable passage with wooden flip-up panel.

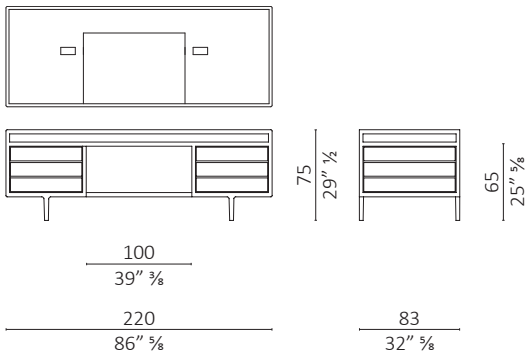

volume m<sup>3</sup> 2,586 - kg. 192

## Finiture / Finishes

### Legno Noce / Wood Walnut



Noce  
Walnut

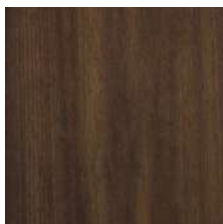

Noce dark  
Walnut dark

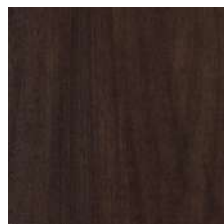

Noce moka  
Walnut moka

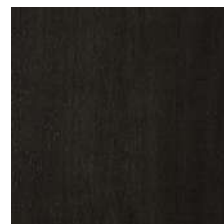

Noce brown  
Walnut brown

## Finiture / Finishes

### Pelle / Leather Color Sphere PF

---



SC 06 Calicot



SC 23 Tortora

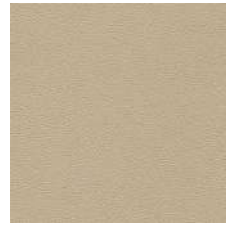

SC 32 Caolino

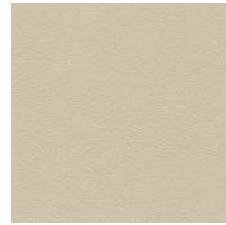

SC 51 Panna

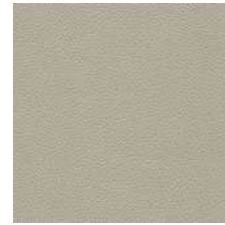

SC 31 Quarzo Fumè

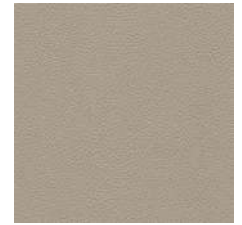

SC 34 Maggese



SC 26 Topo



SC 20 Inchiostro



SC 21 Amianto



SC 53 Creta



SC 55 Camel Hair



SC 52 Daino



SC 66 India



SC 59 Noce di Pecan



SC 80 Bruno Havana



SC 29 Ardesia



SC 148 Lacca



SC 146 Coccio Pesto



SC 173 Glauco



SC 177 Limo



SC 178 Alpi



SC 254 Steel Blue



SC 278 Atlantic Blue



SC 279 Alchemy

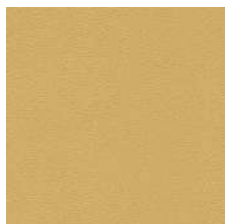

SC 133 Paglierino