

DC 100/85/150/220/280

design Vincenzo De Cotiis

Caratteristiche tecniche - Chaise longue, pouf e divano con base in legno massello e schienale in multistrato curvato, imbottiti con poliuretano espanso non deformabile di varie densità. Custodia protettiva in fibre di poliestere, seduta con cinghie e rivestimento non rimovibile. Con cuscini cm 65x65.

Technical features - Chaise longue, pouf and sofa with base in solid wood and back-rest in curved plywood, padded with non-deformable polyurethane foam of various densities. Protective cover in polyester fiber, seat with straps, non-removable covering. With cushions cm 65x65.



DC 100

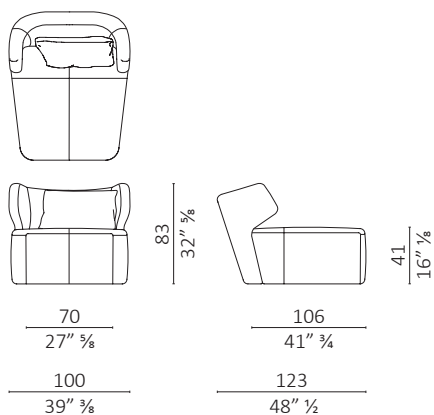

c.o.m. (l.mt.6,50/sq.mt.12,50)
volume m³ 1,324 - **kg.** 63

DC 150

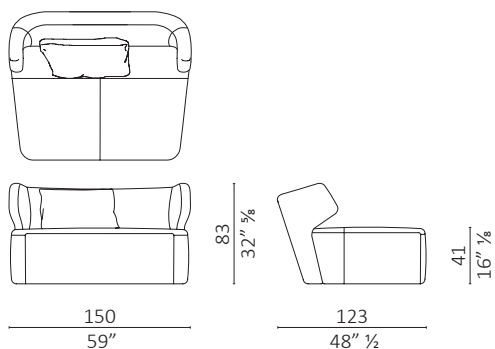

c.o.m. (l.mt.8,30/sq.mt.13,50)
volume m³ 1,877 - **kg.** 77

DC 85

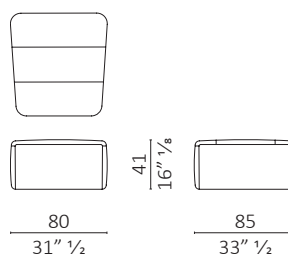

c.o.m. (l.mt.2,90/sq.mt.4,00)
volume m³ 0,332 - **kg.** 27

DC 220

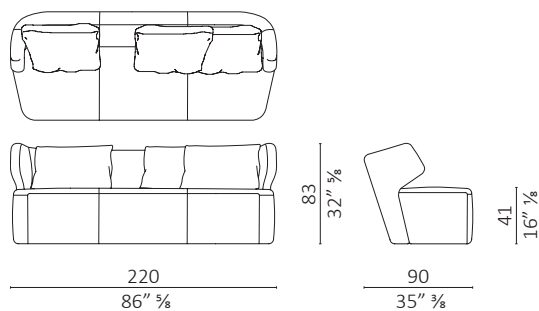

c.o.m. (l.mt.12,00/sq.mt.23,00)
volume m³ 2,539 - **kg.** 105,5

DC 280

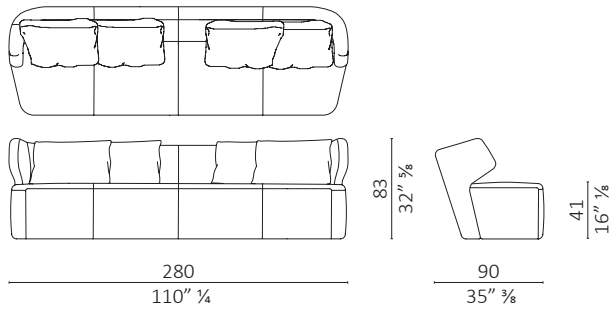

c.o.m. (l.mt.13,20/sq.mt.26,50)
volume m³ 3,187 - kg. 131

Finiture / Finishes

Tessuto Velluti e Ciniglie / Fabric Velvet and Chenille



Belsuede-029



Belsuede-032



Belsuede-015



Belsuede-014



Belsuede-01



Belsuede-036



Belsuede-016



Belsuede-017



Belsuede-040



Belsuede-034



Belsuede-010



Belsuede-011



Belsuede-012



Belsuede-039



Amazonie-041



Amazonie-042

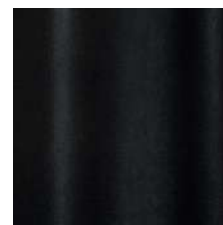

Amazonie 002



Amazonie 022

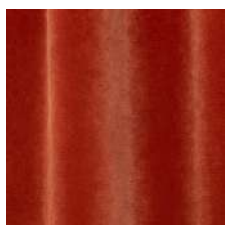

Amazonie 025

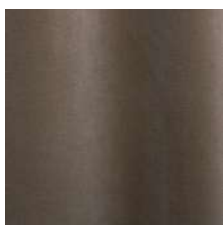

Amazonie 045

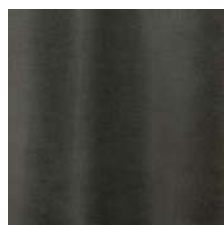

Amazonie 040



Amazonie 043

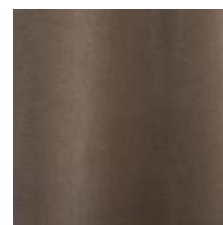

Amazonie 036

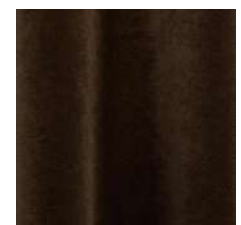

Amazonie 038

Finiture / Finishes

Tessuto Velluti e Ciniglie / Fabric Velvet and Chenille

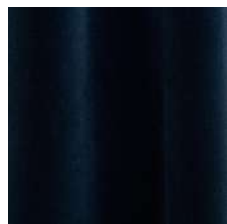

Amazonie 037



Amazonie 035

Tessuto / Fabric Bouclé



Verone Creme



Monza 00



Mies-005



Monza 09



Mies-004



Monza 07



Monza 97

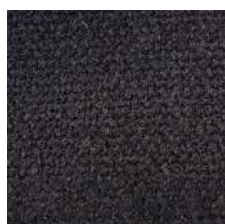

Monza 84



Monza 58



Monza 27



Monza 48



Monza 45

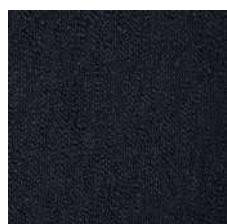

Verone Nuit



Mies-020

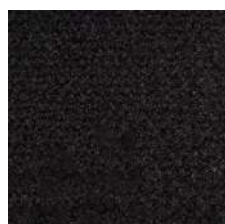

Monza 88



Mies-008

Tessuto Vari / Fabric Various

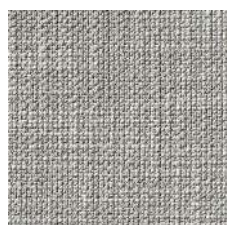

Gypsy-892

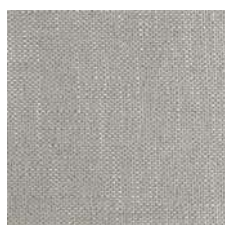

Flair-108



Nyul 001

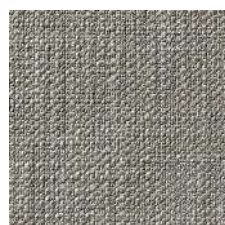

Gypsy-895



Divina 3 224



Oxford-893

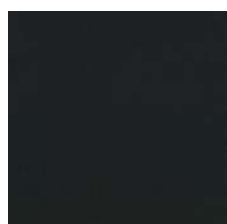

Divina 3-191

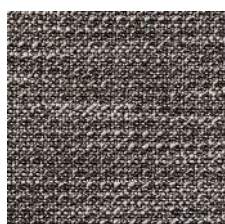

Oxford-897



Flair-121

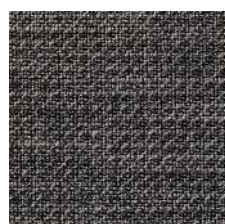

Oxford-999

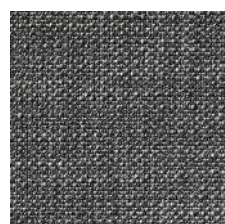

Gypsy-997

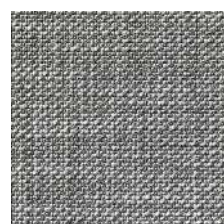

Gypsy-995

Finiture / Finishes

Tessuto Vari / Fabric Various



Nylul 002



Nylul 003



Flair 166



Oxford-889



Flair-164

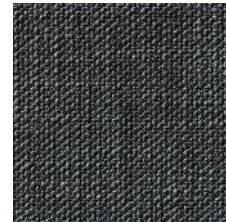

Gypsy-699



Nylul 004



HURLUBERLU 003



HURLUBERLU 004

Pelle / Leather Color Sphere PF



SC 06 Calicot



SC 23 Tortora



SC 32 Caolino



SC 51 Panna



SC 31 Quarzo Fumè



SC 34 Maggese



SC 26 Topo

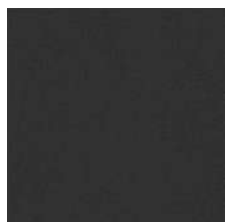

SC 20 Inchiostro



SC 21 Amianto



SC 53 Creta



SC 55 Camel Hair



SC 52 Daino



SC 66 India



SC 59 Noce di Pecan



SC 80 Bruno Havana



SC 29 Ardesia



SC 148 Lacca



SC 146 Coccio Pesto



SC 173 Glauco



SC 177 Limo



SC 178 Alpi



SC 254 Steel Blue



SC 278 Atlantic Blue



SC 279 Alchemy

Finiture / Finishes

Pelle / Leather Color Sphere PF

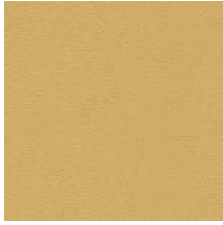

SC 133 Paglierino

PELLE SUPERIOR / SUPERIOR LEATHER



201 Testa di moro



202 Antracite



204 Fango



Velvety - Black Pepper



Velvety - Clary Sage

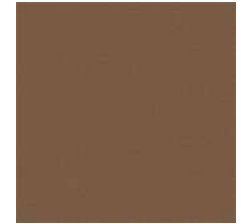

Velvety - Cumin

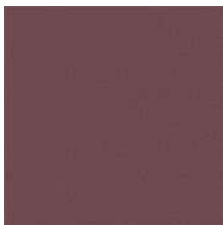

Velvety - Deep
Lavender

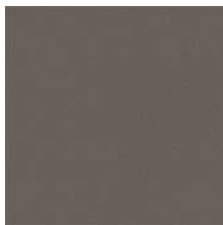

Velvety - Grey Salt



Velvety - Juniper

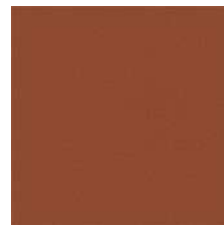

Velvety - Paprika



Velvety - Rosemary



Velvety - Saffron



Velvety - Sesame